

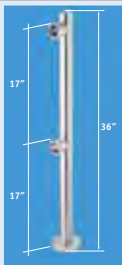

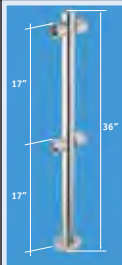

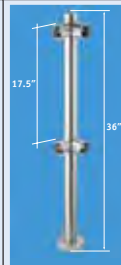

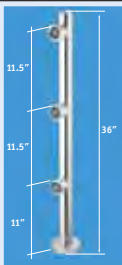
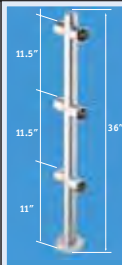
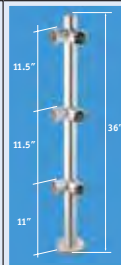
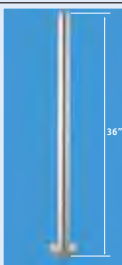

Buy direct from the manufacturer, we will not be undersold  
All components are in stock, available for immediate shipping

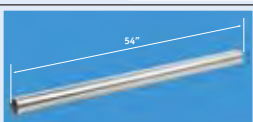
**Railing system components**

 <p><b>1. PE-2</b> End Post, 2" dia. nom x 36" long complete with, 2 horizontal connectors(PCN-1), 2 internal connectors(IC-1) for double line, Top cap(PC-1), floor flange, flange cover, qty-4 3/8"dia. X 3" long floor anchors, qty-4 #8 x 3/4" long self drilling screws, all stainless steel construction</p>	 <p><b>2. PM-2</b> Middle Post, 2" dia. nom x 36" long complete with, 4 horizontal connectors(PCN-1), 4 internal connectors(IC-1) for double line, Top cap(PC-1), floor flange, flange cover, qty-4 3/8"dia. X 3" long floor anchors, qty-4 #8 x 3/4" long self drilling screws, all stainless steel construction</p>	 <p><b>3. PC-2</b> Corner Post, 2" dia. nom x 36" long complete with, 4 horizontal connectors(PCN-1), 4 internal connectors(IC-1) for double line at 90 degrees, Top cap(PC-1), floor flange, flange cover, qty-4 3/8"dia. X 3" long floor anchors, qty-4 #8 x 3/4" long self drilling screws, all stainless steel construction</p>
 <p><b>4. PE-3</b> End Post, 2" dia. nom x 36" long complete with, 3 horizontal connectors(PCN-1), 3 internal connectors(IC-1) for triple line, Top cap(PC-1), floor flange, flange cover, qty-4 3/8"dia. X 3" long floor anchors, qty-4 #8 x 3/4" long self drilling screws, all stainless steel construction</p>	 <p><b>5. PM-3</b> Middle Post, 2" dia. nom x 36" long complete with, 6 horizontal connectors(PCN-1), 6 internal connectors(IC-1) for triple line, Top cap(PC-1), floor flange, flange cover, qty-4 3/8"dia. X 3" long floor anchors, qty-6 #8 x 3/4" long self drilling screws, all stainless steel construction</p>	 <p><b>6. PC-3</b> Corner Post, 2" dia. nom x 36" long complete with, 6 horizontal connectors(PCN-1), 6 internal connectors(IC-1) for triple line at 90 degrees, Top cap(PC-1), floor flange, flange cover, qty-4 3/8"dia. X 3" long floor anchors, qty-4 #8 x 3/4" long self drilling screws, all stainless steel construction</p>
 <p><b>7. PB-1</b> Straight post, 2" dia. nom x 36" long complete with, Top cap(PC-1), floor flange, flange cover, qty-4 3/8"dia. X 3" long floor anchors, qty-4 #8 x 3/4" long self drilling screws, all stainless steel construction</p>	 <p><b>8. PC-1</b> Stainless steel cap for 2" dia nom.</p>	 <p><b>10. PCN-1</b> Stainless steel horizontal tube connector for 2" dia, nominal tubing</p>
 <p><b>12. HR-1</b> Stainless steel tube 2" dia. nom x 54" long</p>	 <p><b>9. IC-1</b> Internal connector for 2" dia. Nominal tubing</p>	 <p><b>11. CB-1</b> Stainless steel 2" dia, nominal tubing, 6" internal radius, 90 degrees with 6" outside bend length, 2 sides</p>
	 <p><b>13. FA-1</b> 3/8" dia. x 3" floor anchors, steel, zinc plated</p>	 <p><b>14. CB-2</b> Stainless steel 2" dia. Nominal tubing, 6" bend radius, 60 degrees, 2 sides</p>

Contact our 24/7 Technical Support Team at 1-866-940-Gate  
OR visit our website at [www.integraltech.ca/irail](http://www.integraltech.ca/irail)  
[irail@integraltech.ca](mailto:irail@integraltech.ca)



3359 Griffith St.  
Saint-Laurent  
Quebec, H4T 1W5

T (514) 738-7715  
T (866) 940-GATE (4283)  
F (514) 738-7913  
[info@integraltech.ca](mailto:info@integraltech.ca)



[www.integraltech.ca](http://www.integraltech.ca)



**Control Retail Traffic in Your Store Environment**



**Stainless steel construction:**

-  Strong, durable, maintenance free, retains its mirror finish for years
-  Will not tarnish, peel or crack upon impact
-  Will not be affected by caustic cleaning chemicals



Endorsed by  Association des détaillants en alimentation du Québec



## Reduce and control retail traffic within your store environment.

*Iraill modular posts and railing systems can be used to create virtually any railing configuration. Iraill solutions offer a number of standard posts with connectors and one standard railing length in stainless steel, which can be tailored to any custom installation. All this and more; ready for immediate shipment.*



*The uses of Iraill's modular railing components are endless and limited only by your retail space and your imagination. Typical uses include, channeling customers, limiting access to areas, queuing, designating areas, providing a backing for pallet or merchandise storage, or as an indoor cart corral.*

*An integrated railing system also adds an additional deterrent to shoplifters. Thieves are constantly handing-off unpaid merchandise through the stores unprotected entrance, now you can keep your in-store traffic away from potential accomplices on the outside.*

*Combining Iraill posts and railings with Integral's Sheriff or Deputy Entrance Security Systems is a highly cost effective and efficient use of space for calming consumer traffic, channeling customers and reducing shrinkage in retail applications.*

### Iraill - Double Rail System

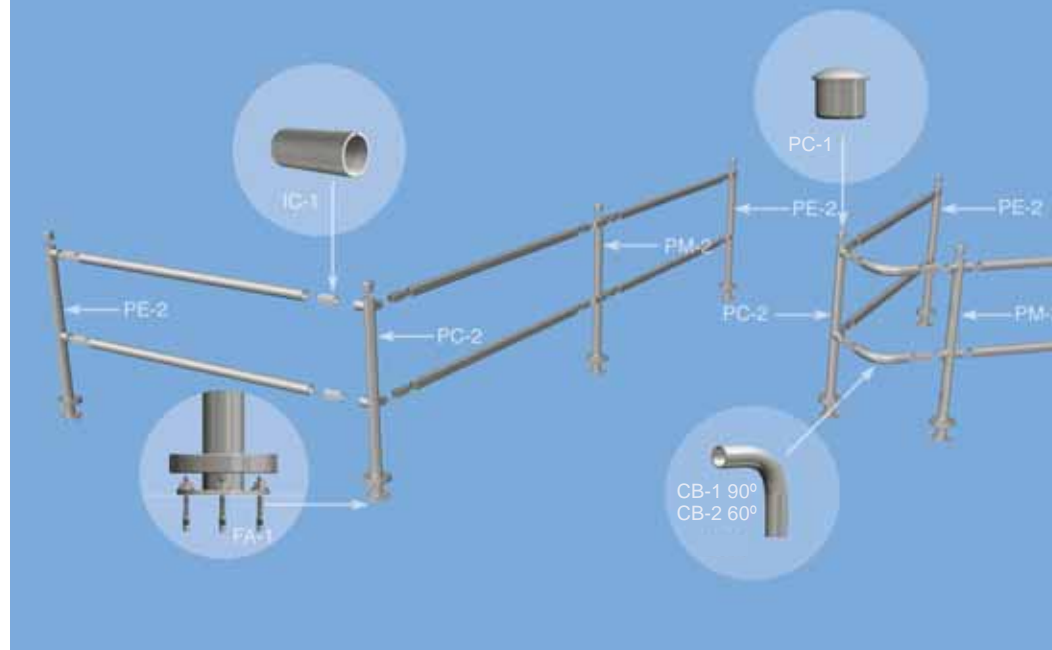

### Iraill - Triple Rail System

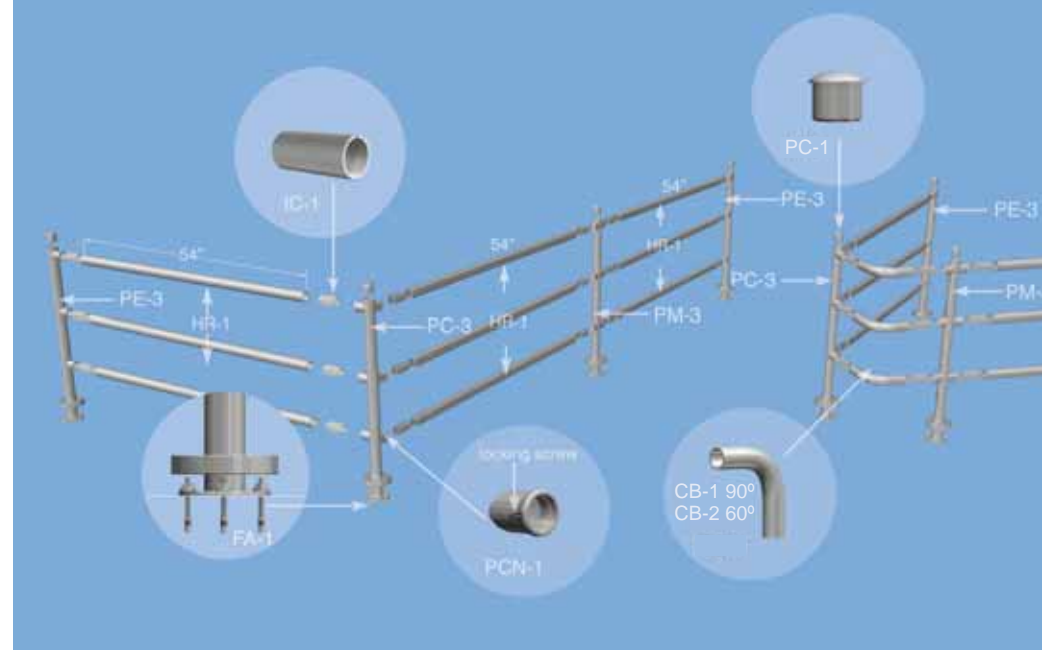

Super C: Montreal, QC.

